

ACVATIX™

6-port control ball valve

VWG41..



6-port control ball valves, PN 16, with externally threaded connection.

- Control ball valve body made of hot-pressed brass CW617N
- DN 10 and DN 20
- k_{vs} 0.25...4.25 m³/h
- Flat sealing, externally threaded connections G..B, per ISO 228-1
- Fitting sets ALN..B with external threading per ISO 228-1
- Fitting sets ALN..B with internal threading per ISO 7-1
- Insulation shell made of PPE, halogen-free
- Rotational angle 90°
- VWG.41.20.. and VWG41.10.. can be combined with electromotoric rotary actuators GDB..9E.. without spring return
- VWG41.10.. can also be combined with electromotoric rotary actuators GSD..9A.. without spring return

Use

- Used in heated/chilled ceilings as control ball valve.
- For closed circuit (see Cavitation).
- Inexpensive: Only one valve with actuator is needed to control a heated and chilled ceiling.
- Flexible: Various connections can be implemented thanks to external threading.
- Simple: The brackets, premounted on the actuators, means you can mount them on the ball valves without tools.

Technical design

Sizing

Ball characteristic curve DN10

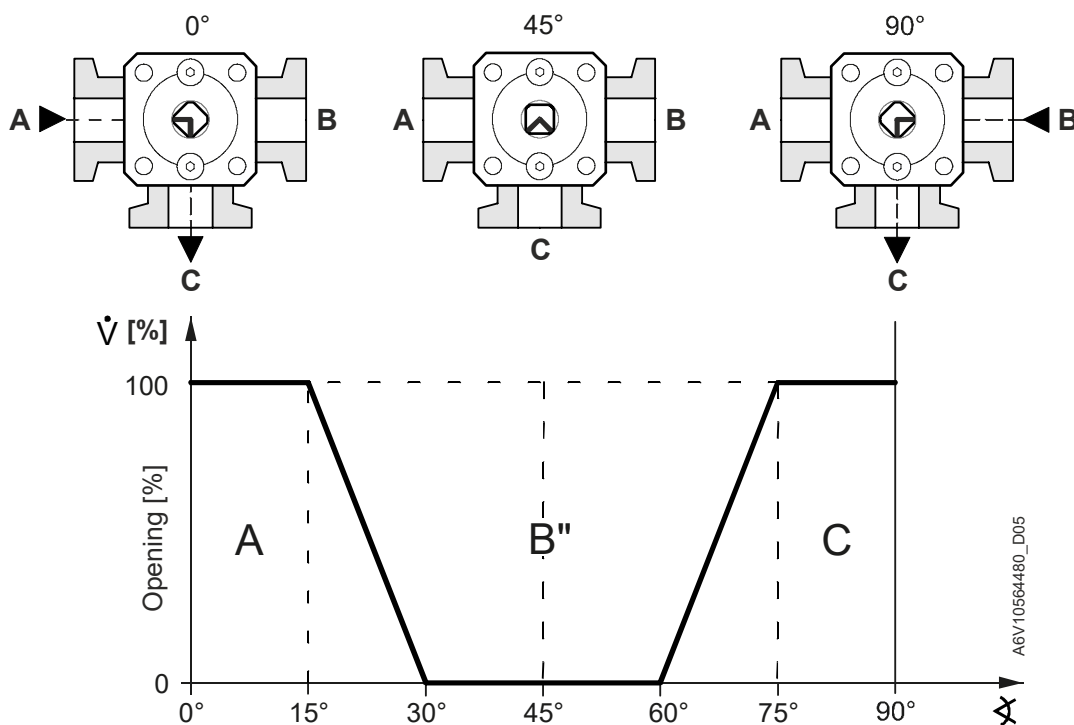

Ball characteristic curve DN20

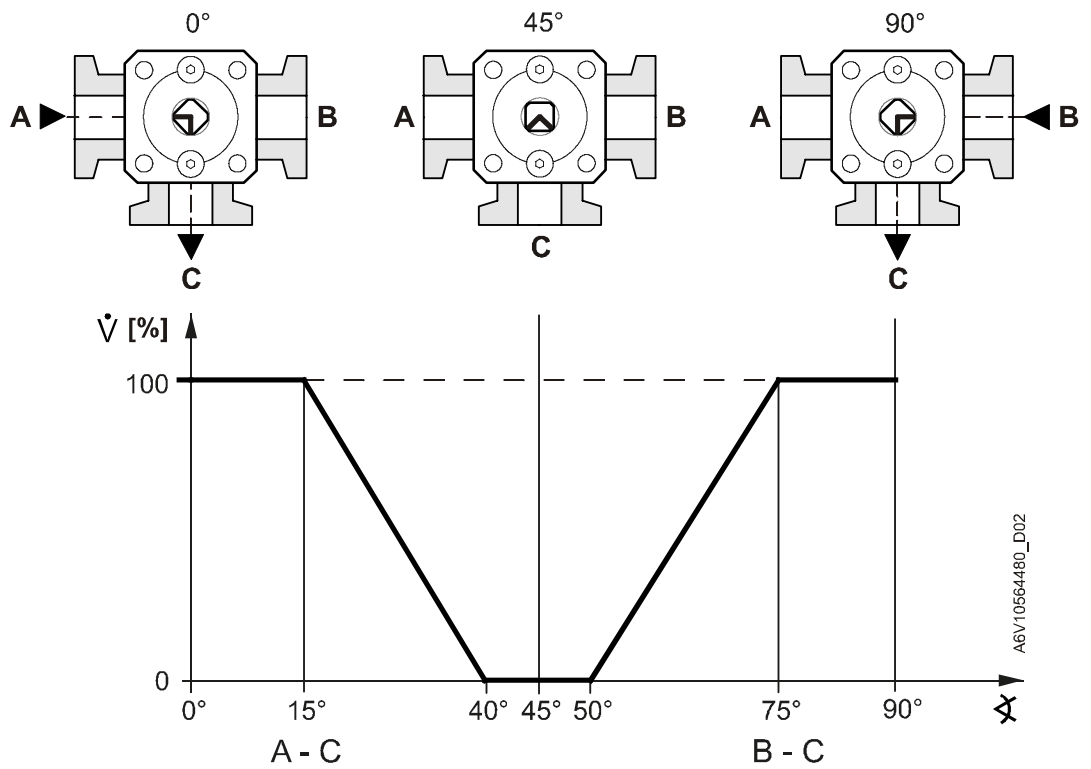

The 6-port control ball valve enables control between two sources through positions 0° and 90°. The 6-port control ball valve is closed at 45°.

Flow diagram DN10

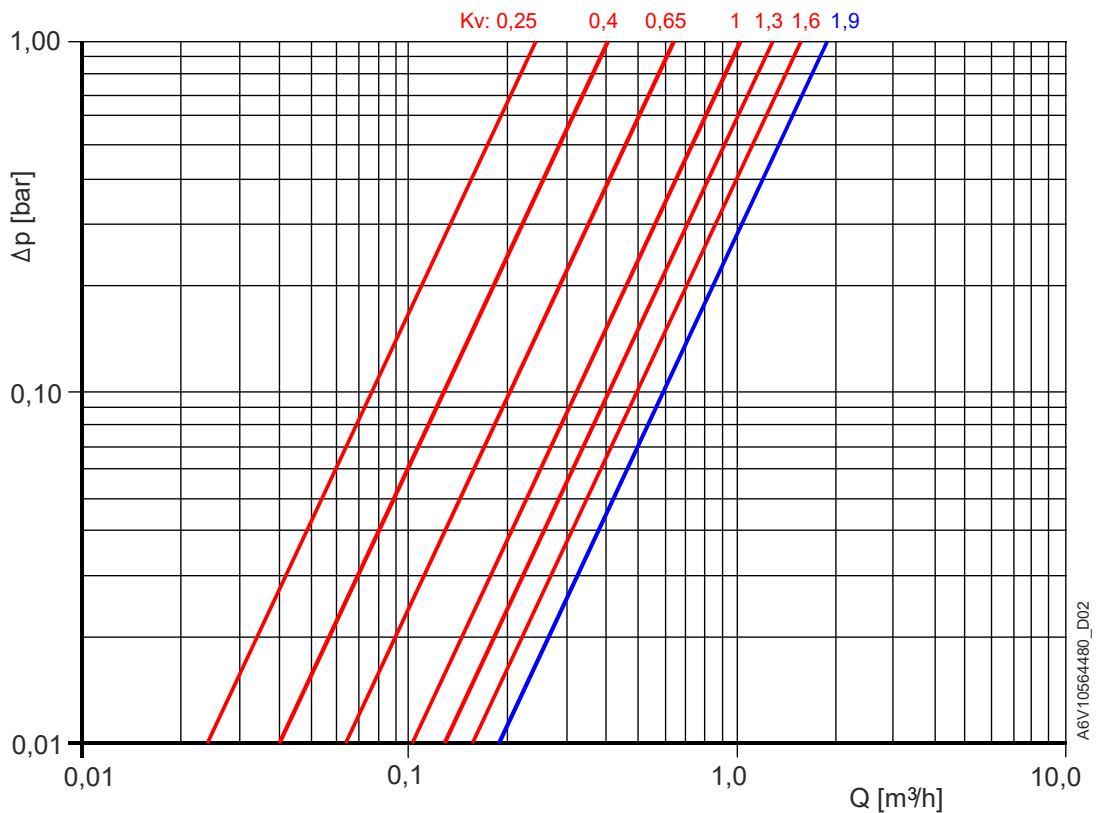

Flow diagram DN20

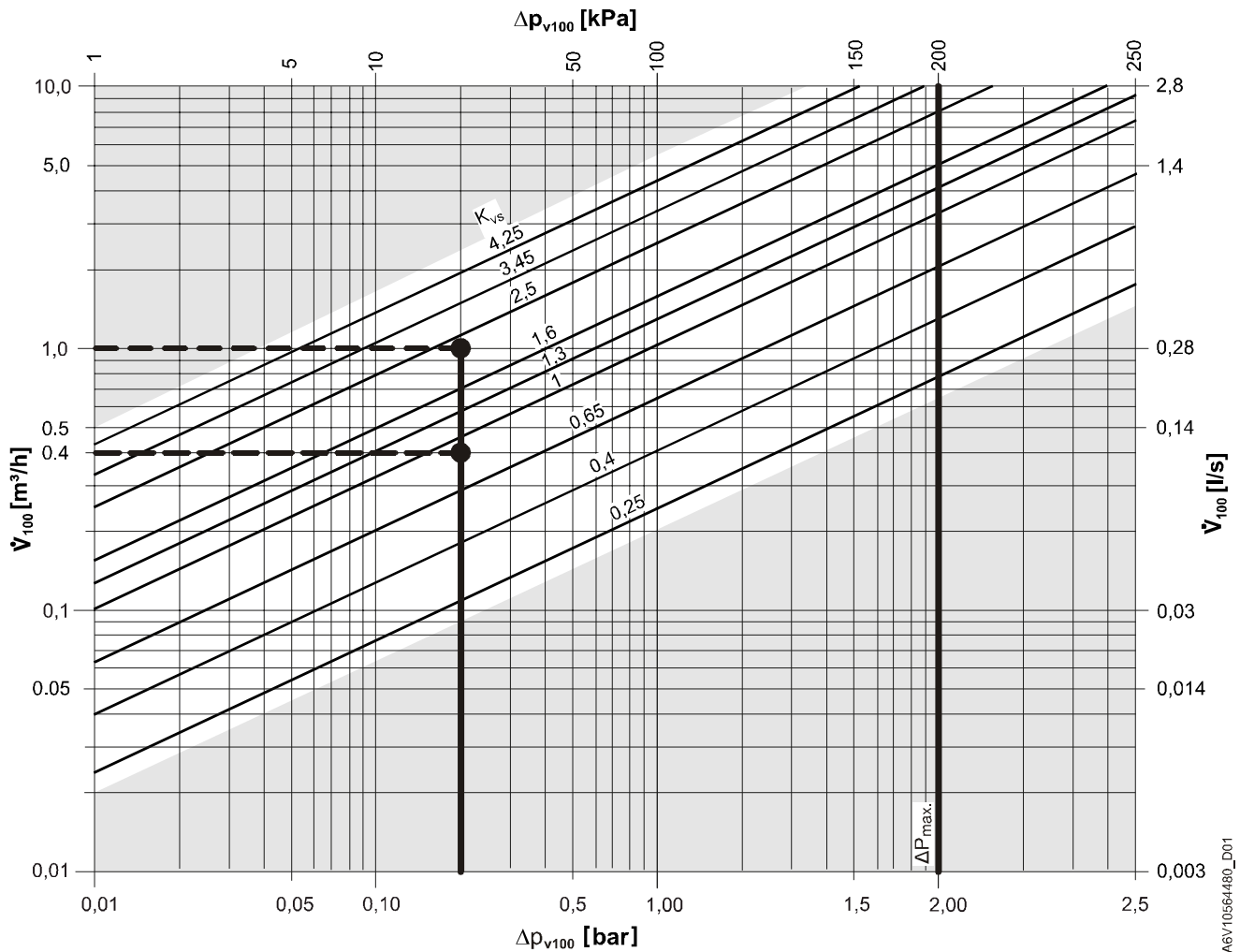

Δp_{\max}	=	Maximum permissible differential pressure over the ball valve (flow and return), valid for the entire positioning range of the ball valve rotary actuator unit:
Δp_{v100}	=	Differential pressure over the fully opened ball valve (flow and return) and over the control path at a volume flow V_{100}
V_{100}	=	Volume flow through the fully opened ball valve
100 kPa	=	1 bar \approx 10 mWS
1 m ³ /h	=	0.278 l/s water at 20 °C

Example on sizing

Sizing:

Design

Q_H	=	2.8 kW
ΔT_H	=	6 K
Q_K	=	2.4 kW
ΔT_K	=	2 K
Δp_{v100}	=	20 kPa
ρ_{Water}	=	1000 kg/m ³

Determining volumetric flow

$$V_H = \frac{Q_H}{\Delta T \cdot c \cdot \rho} = \frac{2800 \text{ W} \cdot \text{kg} \cdot \text{K} \cdot \text{m}^3}{6 \text{ K} \cdot 1,163 \text{ Wh} \cdot 1000 \text{ kg}} = 0,4 \frac{\text{m}^3}{\text{h}}$$

$$V_K = \frac{Q_K}{\Delta T \cdot c \cdot \rho} = \frac{2400 \text{ W} \cdot \text{kg} \cdot \text{K} \cdot \text{m}^3}{2 \text{ K} \cdot 1,163 \text{ Wh} \cdot 1000 \text{ kg}} = 1,0 \frac{\text{m}^3}{\text{h}}$$

Selection of orifices

Heating:	1.0
Cooling:	2.5

Type summary

Type	Order number	DN	k_{vs} left	k_{vs} right	Fittings			
			[m ³ /h]	[m ³ /h]	15	20	25	
VWG41.10-0.25-0.4	S55230-V158	10	0.25	0.4	X	-	-	
VWG41.10-0.25-0.65	S55230-V159		0.25	0.65	X	-	-	
VWG41.10-0.25-1.0	S55230-V160		0.25	1	X	-	-	
VWG41.10-0.4-0.65	S55230-V161		0.4	0.65	X	-	-	
VWG41.10-0.4-1.0	S55230-V162		0.4	1	X	-	-	
VWG41.10-0.4-1.3	S55230-V163		0.4	1.3	X	-	-	
VWG41.10-0.4-1.6	S55230-V164		0.4	1.6	X	-	-	
VWG41.10-0.65-1.0	S55230-V165		0.65	1	X	-	-	
VWG41.10-0.65-1.3	S55230-V166		0.65	1.3	X	-	-	
VWG41.10-0.65-1.6	S55230-V167		0.65	1.6	X	-	-	
VWG41.10-1.0-1.3	S55230-V168		1	1.3	X	-	-	
VWG41.10-1.0-1.6	S55230-V169		1	1.6	X	-	-	
VWG41.10-1.0-1.9	S55230-V170		1	1.9	X	-	-	
VWG41.10-1.3-1.6	S55230-V171		1.3	1.6	X	-	-	
VWG41.10-1.3-1.9	S55230-V172		1.3	1.9	X	-	-	
VWG41.10-1.6-1.9	S55230-V173		1.6	1.9	X	-	-	
VWG41.10-1.9-1.9	S55230-V174		1.9	1.9	X	-	-	
VWG41.20-0.25-0.4	S55230-V142		20	0.25	0.4	X	X	X
VWG41.20-0.25-0.65	S55230-V143	0.25		0.65	X	X	X	
VWG41.20-0.25-1.0	S55230-V144	0.25		1	X	X	X	
VWG41.20-0.4-1.0	S55230-V145	0.4		1	X	X	X	
VWG41.20-0.4-1.3	S55230-V146	0.4		1.3	X	X	X	
VWG41.20-0.4-1.6	S55230-V147	0.4		1.6	X	X	X	
VWG41.20-0.65-1.0	S55230-V148	0.65		1	X	X	X	
VWG41.20-0.65-1.6	S55230-V149	0.65		1.6	X	X	X	
VWG41.20-0.65-2.5	S55230-V150	0.65		2.5	- ¹⁾	X	X	
VWG41.20-1.0-1.6	S55230-V151	1		1.6	X	X	X	
VWG41.20-1.0-2.5	S55230-V152	1		2.5	- ¹⁾	X	X	
VWG41.20-1.6-2.5	S55230-V153	1.6		2.5	- ¹⁾	X	X	
VWG41.20-1.6-3.45	S55230-V154	1.6		3.45	- ¹⁾	X	X	
VWG41.20-2.5-3.45	S55230-V155	2.5		3.45	- ¹⁾	X	X	
VWG41.20-2.5-4.25	S55230-V156	2.5		4.25	- ¹⁾	- ¹⁾	- ¹⁾	
VWG41.20-4.25-4.25	S55230-V157	4.25		4.25	- ¹⁾	- ¹⁾	- ¹⁾	
DN	=	Nominal size						
k_{vs}	=	Flow nominal value for chilled water (5...30 °C) through a fully opened ball valve at a differential pressure of 100 kPa (1 bar)						
X	=	Flow nominal value is possible						
¹⁾	=	Flow is restricted. For DN15: 1.6 m ³ /h; for DN20: 3.45 m ³ /h; for DN25: 4.0 m ³ /h						

ASN key

Example:

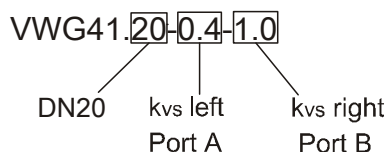

Fittings

Type	Order no.	Description
ALN15.152B	S55845-Z156	Fittings set made of brass for media temperatures up to 90°C, consisting of <ul style="list-style-type: none"> • 2x cap nuts • 2x cap nuts with sleeves and insert per ISO 228-1 • 2x flat seals
ALN15.202B	S55845-Z157	
ALG13.152B	S55845-Z195	Fittings set made of brass for media temperatures up to 90°C, consisting of <ul style="list-style-type: none"> • 2x cap nuts with sleeves and insert per ISO 7-1 • 2x flat seals
ALG15.152B	S55845-Z158	Fittings set made of brass for media temperatures up to 90°C, consisting of <ul style="list-style-type: none"> • 2x cap nuts with sleeves and insert per ISO 7-1 • 2x flat seals
ALG15.202B	S55845-Z159	
ALG15.252B	S55845-Z160	

Insulation shells

Type	Order no.	Description
ALI10VWG41	S55845-Z194	Insulation shell for VWG41.10..
ALI20VWG41	S55845-Z161	Insulation shell for VWG41.20..

Equipment combinations

Type	Rotary actuators			
	Type of use	Δp_{max}	Type of use	Δp_{max}
VWG41.20..	GDB161.9E, GDB161.9E/37		GDB111.9E/KN	
	Control ball valve	200 kpa	Control ball valve	200 kpa
	GDB341.9E		GLB111.9E/MO	
	Toggle key	200 kpa	Ball valve with Modbus communication	200 kpa
VWG41.10..	GDB161.9E, GDB161.9E/37, GSD161.9A*		GDB111.9E/KN	
	Control ball valve	200 kpa	Control ball valve	200 kpa
	GDB341.9E, GSD341.9A		-	
	Toggle key	200 kpa	Toggle key	200 kpa

Δp_{max} = Maximum permissible differential pressure over the ball valve control path, valid for the entire positioning range of the ball valve rotary actuator unit:

* = GSD161.9A available as of March 2017

Overview of rotary actuators for the 6-port control ball valve

Type	Order number	Torque	Operating voltage	Positioning		Cable length [m]	Data sheet ¹⁾
				Signal	Time		
GDB161.9E	S55499-D275	5Nm	AC/DC 24 V	DC 0/2...10 V	150 s	0.9	A6V10636150
GDB161.9E/37	S55499-D285	5Nm				3.7	
GDB111.9E/KN	S55499-D203	5Nm	AC 24 V	KNX-TP		0.9	A6V10301232
GDB341.9E	S55499-D201	5Nm	AC 100...240 V	2-position		0.9	n/a
GLB111.9E/MO	S55499-D206	10Nm	AC 24 V	Modbus RTU		0.9	Modbus RTU
GSD161.9A*	S55499-D232	2Nm	AC/DC 24 V	DC 0...10 V	30 s	0.9	n/a ²⁾
GSD341.9A	BPZ:GSD341.9A	2Nm	AC 230 V	2-position	30 s	0.9	N4655

¹⁾ Documents can be downloaded at the Internet address, see Section "Product documentation".

²⁾ GSD161.9A is available as of March 2017

Application examples for the device combinations: See Section Examples for device combinations

Ordering

Indicate type, order number, order text and number when ordering. Example:

Type	Order number	Order text	Quantity
VWG41.20-0.4-1.3	S55230-V146	6-port control ball valve	1
ALN15.202B	S55845-Z157	2x fittings with ISO 228 external threading	3
GDB161.9E	GDB161.9E	Ball valve actuator, no spring return (NSR)	1

Delivery

6-port control valve (in a closed state), rotary actuator with mounting kits (unassembled), individually packaged.

Product documentation

Topic	Title	Document ID
Mounting	Mounting instructions 6-port control ball valve VWG41..	A6V10564501
Mounting	Mounting instructions rotary actuator G..B..	M4657

Related documents such as environmental declarations, CE declarations, etc., can be downloaded at the following Internet address:

<http://siemens.com/bt/download>

Notes

	NOTICE
	Note the following when servicing a ball valve/rotary actuator:

- Switch off both pump and operating voltage.
- Close shutoff valves.
- Release pressure in the pipes and allow them to cool down completely.
- Disconnect electrical connections from the terminals as needed.
- The rotary actuator must be properly installed prior to recommissioning the ball valve.
- Ensure that there is no cavitation

- Install filter to increase functional security

Technical design/mechanical design

The Siemens 6-port control ball valve has an internal pressure equalization function that ensures the safe operation of heated and chilled ceilings in a closed valve state (45° position) Changes to media temperature in the heated and chilled ceiling can result in over or under pressure in a closed state and may, under certain circumstances even damage part of the heated and chilled ceiling.

The safety function only acts in the closed valve position (45°). The heating and cooling circuits are safely separated while operating.

Safety

	<p>⚠ CAUTION</p>
	<p>National safety regulations Failure to comply with national safety regulations may result in personal injury and property damage.</p> <ul style="list-style-type: none"> • Observe national provisions and comply with the appropriate safety regulations.

	<p>NOTICE</p>
	<p>Use of rotary actuator Commission the 6-port control ball valve only after it is correctly coupled with the rotary actuator.</p>

Mounting

It is easy to assemble the ball valve and rotary actuator; it can be done at the construction site. No special tools or settings required.

The ball valve is delivered with mounting instructions A6V10564501.

For additional information on applicable documentation, see "Product documentation".

	<p>NOTICE</p>
	<p>Conduct a function test before installing the device. Manually operate in full the device one time.</p>

Mounting position

VWG41..

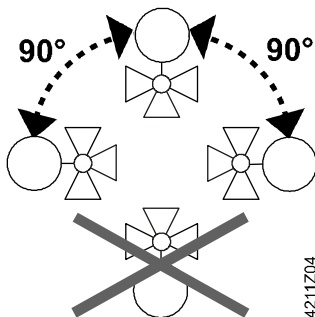

Flow direction

Make sure that the valve is mounted in the proper flow direction. Flow direction is indicated on the ball valve body by the symbol on the type label:

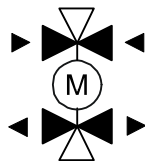

Commissioning

The rotary actuator must be properly mounted before commissioning the 6-port control ball valve. The 6-port control ball valve is delivered in a closed state (middle position).

Maintenance

The 6-port control ball valve VWG41.. is maintenance free.

Disposal



The valve is considered an electronic device for disposal in accordance with the European Guidelines and may not be disposed of as domestic garbage.

- Dispose of the valve through channels provided for this purpose.
- Comply with all local and currently applicable laws and regulations.

Warranty

Technical data on specific applications are valid only together with Siemens products listed under "Equipment combinations". Siemens rejects any and all warranties in the event that third-party products are used.

Technical data

Functional data	VWG41.20..
PN class	PN 16
Operating pressure	16 bar
Maximum differential pressure	2 bar
Leakage rate	"Air tight" per EN 12266-1, class A
Permissible media	Chilled water, hot water, water with anti-freeze (max. 50% glycol). Recommendation: Water treatment per VDI 2035
Medium temperature	5...90 °C
Rotational angle	90 ° Valve closed at 45 °

Materials	
Ball valve body	Hot-pressed brass CW617N
Marble	Brass, chrome plated
Stem	Stainless steel
Stem seal	EPDM-O rings
Adapter plate	Plastic PA66 GF30 / Aluminium alloy

Dimensions / Weight	
See "Dimensions"	
Connections with external threading	G..B per ISO 228-1

Standards, guidelines	
Pressure Equipment Directive	DGR 2014/68/EU
Pressure accessories	Range: Article 1, para. 1 Definition: Article 2, para. 5
Fluid group 2	Without CE certification as per article 4, para. 3 (generally applicable engineering practice) ¹⁾
Environmental compatibility	The product environmental declarations A6V10757071b_en ²⁾ and A6V101006951_--en ²⁾ contain data on environmentally compatible product design and assessments (RoHS compliance, materials composition, packaging, environmental benefit, disposal).
¹⁾ Fittings for a product where PS x DN < 1000, do not require special testing and cannot have CE labeling. ²⁾ Documents can be downloaded at the Internet address, see Section "Product documentation".	

Application examples

Stem rotates counter-clockwise ⇒ Cooling sequence opens

Stem rotates clockwise ⇒ Heating sequence opens

The following applications describe the flow direction in a heated and chilled ceiling.

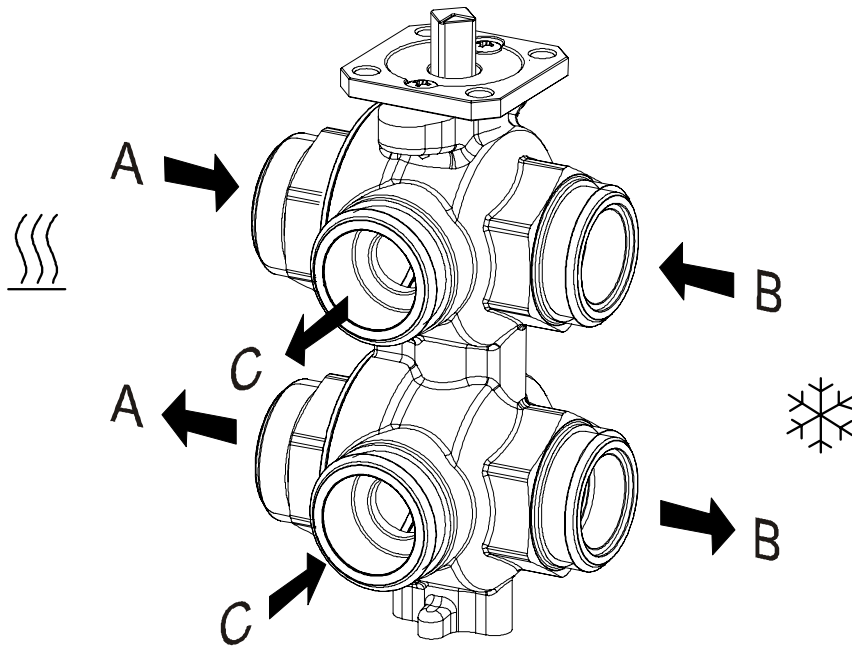

A6V_4480Z07

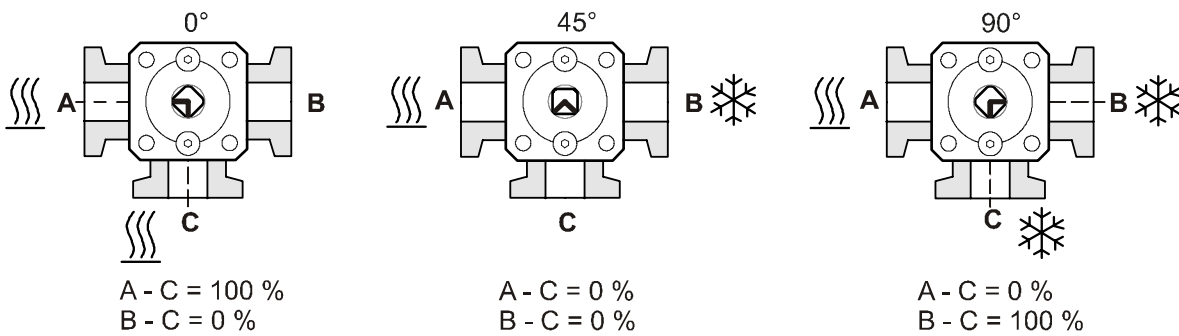

Example: VWG41.20-1.6-2.5

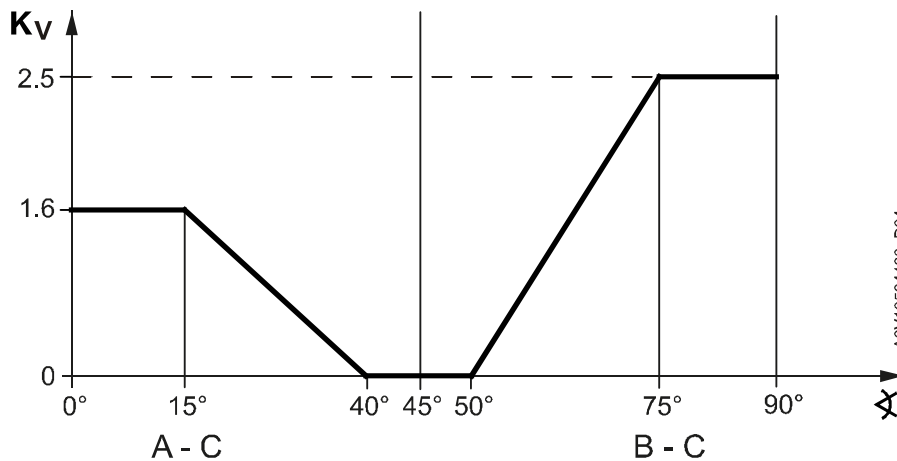

A6V10564480_D04

Examples of device combinations

Hydraulically balanced solution with 6-port ball valve as changeover and PICV as the control element

In this application, the 6-port ball valve changes over between 100% cooling or 100% heating. The PICV valve controls the primary flow for the application.

The following combinations are possible:

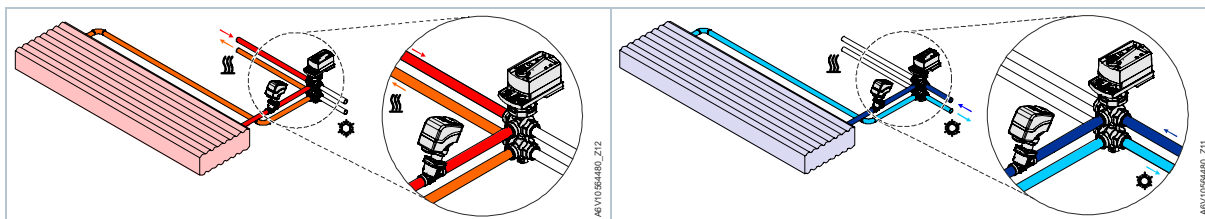

DN20:

1. VWG41.20-4.25-4.25 (1" 6-port ball valve) and GDB341.9E (rotary actuator)
2. VPP46.20 (PICV) and SSA61 (0...10 V actuator)

DN10:

1. VWG41.10-1.9-1.9 (1/2" 6-port valve) and GDB341.9E (5Nm) / GSD341.9A (2Nm) (rotary actuator)
2. VPP46.15 (PICV) and STA63 (0...10 V actuator)

Dimensions

D	=	Nominal size
H	=	Total height of actuator to wall or ceiling, for mounting, connection, operation, maintenance, etc.
H1	=	Dimension from the pipe to the center to install actuator (upper edge)

Type	DN	B	C	D	G	L1	L2	H	H1	H2	H3	H4	H5	Weight
		[mm]	[mm]	[mm]	[inch]	[mm]	[mm]	[mm]	[mm]	[mm]	[mm]	[mm]	[mm]	
VWG41.10..	10	25	50.2	42	G1/2"	32.5	67.5	>305	45.4	36.4	45	27.5	104.1	0.78
VWG41.20..	20	38	67.2	42	G1"	40.5	86.5	>310	51.9	43	60	36.4	134.5	1,796

Fittings

Type	Item NO.	Valve type	G	G1	Rp	DN	C	C1	Weight
-	-	-	[inch]	[inch]	[inch]	-	[mm]	[mm]	[kg]
ALG13.152B	S55845-Z195	VWG41.10..	G 1/2 B	-	RP 1/2	15	35	-	0.140

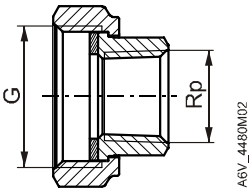
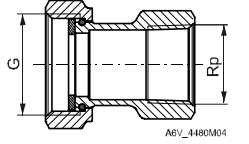
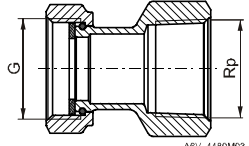
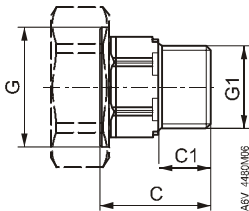
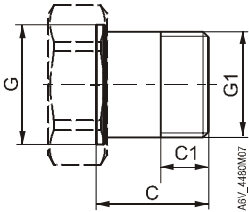
	Type	Item NO.	Valve type	G ISO 228/1	G1 ISO 228/1	Rp ISO 7-1	DN	C	C1	Weight
	-	-	-	[inch]	[inch]	[inch]	-	[mm]	[mm]	[kg]
 ABV_4480M02	ALG15.152B	S55845-Z158	VWG41.20..	G 1 B	-	RP ½	15	-	-	0.183
 ABV_4480M04	ALG15.202B	S55845-Z159	VWG41.20..	G 1 B	-	RP ¾	20	-	-	0.299
 ABV_4480M03	ALG15.252B	S55845-Z160	VWG41.20..	G 1 B	-	RP 1	25	-	-	0.406
 ABV_4480M06	ALN15.152B	S55845-Z156	VWG41.20..	G 1 B	G ½ B	-	15	28	13	0.208
 ABV_4480M07	ALN15.202B	S55845-Z157	VWG41.20..	G 1 B	G ¾ B	-	20	28	12	0.227

Insulation shells

H = Total height of actuator with insulation shell to wall or ceiling, for mounting, connection, operation, maintenance etc.

Type	DN	C	C1	D	D1	E	E1	L	L1	L2	L3	H	Weight
		[mm]	[mm]	[mm]	[mm]	[mm]	[mm]	[mm]	[mm]	[mm]	[mm]	[mm]	[kg]
ALI10VWG41	10	78	39	75	37.5	48	27	135	58	55	32	300	0.017
ALI20VWG41	20	85	42.5	80	40	48	48	160	60	60	40	300	0.026

Filter

TYPE	DN	b	c	G	L	H	K _{vs}	Weight
	[mm]	[mm]	[mm]	[inch]	[mm]	[mm]		
ALX15	15	12	38	1/2	54	27	3.5	0.178
ALX20	20	15	43	3/4	67	34	5.8	0.290
ALX25	25	16	53	1	79	41	9.1	0.410